

ANKO
MITYFLEX PERISTALTIC PUMPS

PERISTALTIC PUMP
OPERATORS MANUAL

FOR UNITS:

909-014 909-023
909-028 909-036
909-049 909-058
909-075 909-108
909-129 909-172
909-203 909-282

QUALITY MANAGEMENT SYSTEM REGISTERED
TO ISO9001 INTERNATIONAL STANDARDS



ANKO PRODUCTS INC. PUMP DIVISION

www.ankoproducts.com

ROLLER BRACKET ASSEMBLY INSTRUCTIONS

For Roller Replacement

- 1) To remove the roller bracket assembly from the pump, use a flat head screwdriver and pry open both sides of the springs to the edge of the bracket.
- 2) Pull the roller bracket assembly off the shaft holding on to the roller area of the bracket.
- 3) Holding the top and bottom of the bracket, slide the spring off to the side and lay the assembly on a flat surface. Try not to let it fall apart as you will need to put it together the same way it is now.
- 4) Remove the top bracket and the rollers.
- 5) If a roller pin comes out of it's recess, replace it at this time.
- 6) Place the new rollers on the pins and replace the top bracket. Be sure that the flat in the inner hole of the top bracket lines up with the flat on the bottom bracket.
- 7) Slide the spring fastener back over the bracket. Do not snap the spring together.
- 8) Matching the roller bracket flat to the output shaft flat, slide the roller bracket assembly down until it stops without using force.
- 9) Snap the spring together.

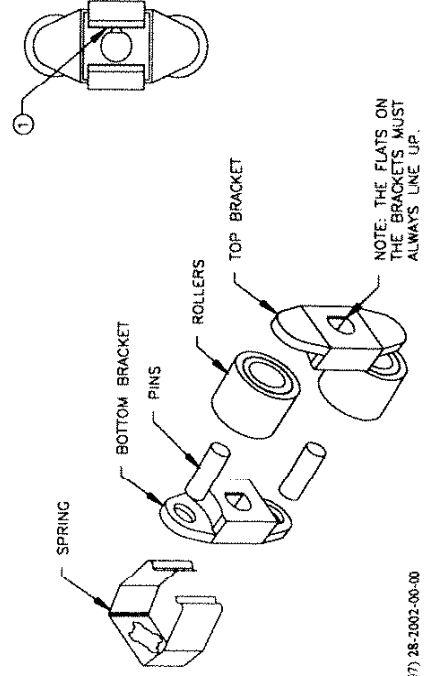

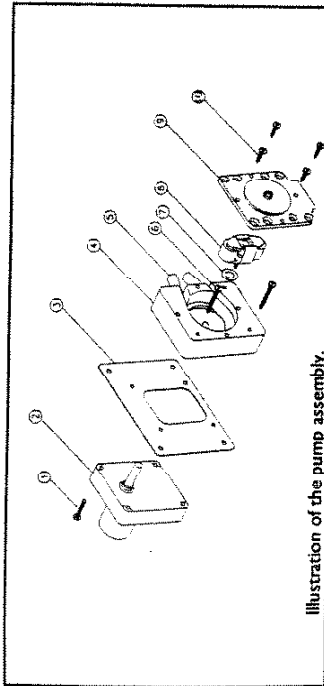

Illustration of the pump assembly.

1 - Screw (1) 8-32 x 7/8"	6 - Mounting Screws (3) 10-32 x 1 1/4"
2 - Gearmotor	7 - Nylon Washer
3 - Mounting Bracket	8 - Roller Bracket Assembly
4 - Pump Housing	9 - Pump Cover
5 - Tubing	10 - Cover Screws (4) 8-32 x .621

Replacement Parts List

Call Customer Service at 800-446-2656 to order. Please remember to include the complete model number when you place your order for replacement parts.

Item	Unit Number
Black Roller Bracket Assembly.....	RB-1212-01-00
Red Roller Bracket Assembly.....	RB-1212-03-00
Pump Kit	907-101-0000-30
(Includes housing, cover w/bearing, four cover screws, 7/8" and 1" mounting screws and washer.)	
Tube Kit.....	TU-1124-0000-01
(Includes 9" of each of the following: 1/16" ID (in a sleeve), 1/8" ID, 3/16" ID & 1/4" ID thermoplastic elastomer tubing. (See chart on page 4 for tubing and roller compatibility.))	

For motor replacement, please call customer service at the phone number above. Have unit number available when calling.

TABLE OF CONTENTS

WARRANTY	2
WARNING	2
RETURN & REPAIR	2
PUMP FEATURES	3
PUMP INSTALLATION	3
FLOW RATES/RPMS	4
ROLLER/TUBING SELECTION	4
TUBING INSTALLATION	5
TUBING INSTALLATION PROCEDURE A	5
TUBING INSTALLATION PROCEDURE B	6
TUBING INSTALLATION PROCEDURE C	7
TUBE SLEEVE ASSEMBLY	7
ILLUSTRATION OF PUMP HEAD ASSEMBLY	8
REPLACEMENT PARTS LIST	8

Thank you for purchasing an Anko Mityflex™ Peristaltic pump. We are sure you will be completely satisfied with its performance. Should you need assistance or have questions regarding the use or installation, please call: 941-749-1960

LIMITED WARRANTY

ANKO PRODUCTS, INC., warrants equipment of its manufacture and bearing its identification to be free from defects in workmanship and material. ANKO PRODUCTS, INC.'s liability under this warranty extends for a period of one year from the date of delivery from our factory or authorized distributor. It is limited to repairing or replacing any device or part of any device which is returned, transportation prepaid, to the factory within one year of delivery to the original purchaser, and which is proven to be defective upon examination by us. ANKO PRODUCTS, INC. disclaims all liability for consequential damage of whatever nature, damage of equipment during transportation, damage due to improper handling, installation or improper operation or for determining suitability for the particular use intended by the purchaser. Replaceable parts including tubes supplied with the product are not covered by any warranties either express or implied. ANKO PRODUCTS, INC., makes no warranties either express or implied, including implied warranty or merchantability, other than those stated above. No representative has authority to change or modify this warranty in any respect. Jurisdiction and venue for enforcement of this warranty may be brought only in the State of Florida. This warranty gives you specific legal rights, and you may also have other rights which vary from state to state.

WARNING

Anko Products assumes no responsibility or liability for chemical compatibility of our tubing in specific applications. ALWAYS pretest tubing in accordance with tubing manufacturer's specifications. Tubing that shows signs of swelling, embrittlement or other deterioration should not be used.

RETURN AND REPAIR REQUESTS

Please direct all warranty and repair requests to Anko Products, Inc. Customer Service Department. Before returning any unit please call 1-941-749-1960 to request an authorized return number.

THE RETURN AUTHORIZATION NUMBER MUST BE MARKED CLEARLY ON THE RETURN PACKAGE.

Every precaution for accuracy has been taken in the preparation of this manual, however, Anko Products, Inc. neither assumes responsibility for any omissions or errors that may appear nor assumes liability for any damages that result from the use of the products in accordance with the information contained in the manual.

PROCEDURE C

Without removing the pump cover, run the unit at high RPM. Pull the old tubing out from outlet port of pump. Install new tube by inserting into inlet port; continue feeding tube 1/4" in at a time allowing the roller assembly to push tubing through. When tubing is half way around the race, put your finger over the inlet hole of the tube and continue to feed tubing 1/4" at a time, this should make installation easier. Continue until desired tubing extension is obtained. Run unit for about one minute.

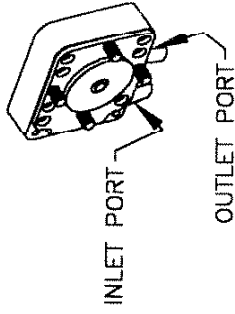

TUBE/SLEEVE ASSEMBLY

Insert the 1/16" tubing into the sleeve and pull through the desired length. Secure by placing tie fastener approximately 1/4" from one end of the sleeve and tighten fastener so that 1/16" tubing is not easily moved. Be careful not to over tighten and collapse the inner tubing. Install the tubing with the tie fastener on the inlet side of the pump. (See illustration above)

Note: Be sure fastener is on the outside of the pump housing and is not interfering with the roller assembly.

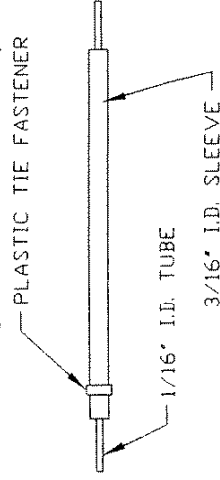

PROCEDURE B

Follow steps 1 - 5 in procedure A, then continue with the following:

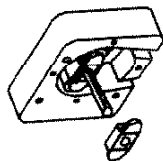

FIG. 1

6. Using extra bracket (figure 1), rotate roller bracket assembly until it is in position as in figure 2. (Be sure power is disconnected)

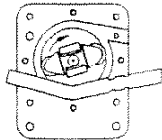

FIG. 2

7. Push new tubing into inlet port, anchoring the tubing in grippers (see figure 3). If using 9" piece of tube, 1 1/2" should be extended outside of inlet port.

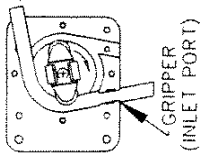

FIG. 3

8. Continue to rotate the roller bracket assembly using the extra bracket, while pushing the tubing into the roller race. (Figure 4)

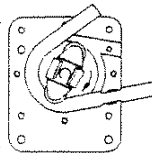

FIG. 4

9. Insert the tubing into the outer port (Figure 5) and replace the cover and screws.

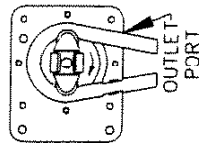

FIG. 5

WARNING

Anko Products assumes no responsibility or liability for chemical compatibility of our tubing in specific applications. ALWAYS pretest tubing in accordance with tubing manufacturer's specifications. Tubing that shows signs of swelling, embrittlement or other deterioration should not be used.

The MITYFLEX™ 909 models are fixed speed general purpose pumps for dispensing fluid based products. They are manufactured with a zinc plated steel bracket for convenient assembly to your OEM application.

FEATURES

- ELECTRICAL:** 12 or 24 VDC
- PRIMING:** Unit is self priming and will hold vacuum when turned off.
- OPERATION:** Pump can run dry without damaging the motor or drive unit, however the tubing life will be reduced.
- CONSTRUCTION:** Polypropylene housing using stainless steel fasteners.
- MAX. HEAD PRESSURE:** 40 PSI. Normal pressure 18 PSI varies depending on tubing used.
- MAX. SUCTION LIFT:** 29 feet (8.8m) with H₂O.
- RATING:** DC gearmotors are rated for 100% continuous operation at 40°C ambient.
- FLOW RATE:** 3 - 987 ml/min.
- FLOW RANGE:** See Page 4.

INSTALLATION INSTRUCTIONS

- POWER REQUIREMENTS:** Voltage and frequency of power supply must be the same as shown on unit.
- WIRING CONNECTIONS:** All wiring and electrical connections must comply with local and national electrical codes.
- MOUNTING:** Mounting bracket for OEM applications. Be sure that there is plenty of space for air circulation. Do not allow tubing to be crimped.
- MOUNTING LOCATION:** Pump should be placed in a dry location with adequate cooling provided. The ambient temperature should not exceed 40°C.

WARNING:

This unit should not be used in outdoor or hazardous locations.

FLOW RATES

ML/MIN - RPMs

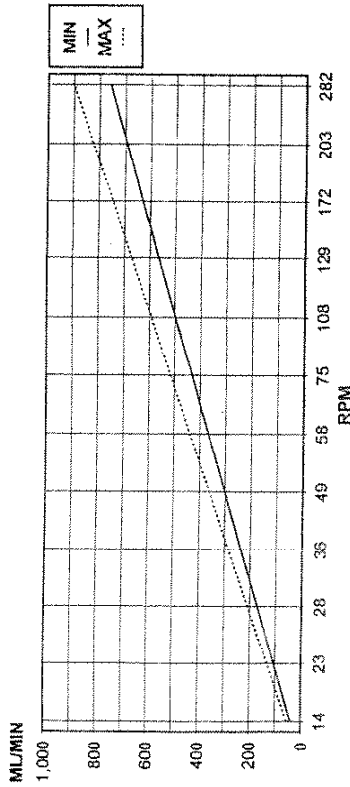

Flow range based on pumping water at 25°C and 0 PSI using 60 durometer thermoplastic elastomer tubing.

ROLLER/TUBING SELECTION

Use the following color coded rollers with the appropriate tubing I.D. Your unit is assembled with black rollers. Red rollers are included in your tubing kit. See separate instructions for roller replacement enclosed in your tube kit.

Roller	Tubing ID	ML/Revolution
Black	1/4" (.250)	3.5
Black	3/16" (.187)	2.1
Red	1/8" (.125)	0.8
Red	1/16"***	0.21

*The 1/16" ID tubing must be inserted into a 3/16" (.187) ID X 3/8" (.375) OD tubing (sleeve) for operation in pump. (See instructions on page 7.)

CAUTION: Avoid prolonged operation in the stalled position to assure longer motor life.

TUBING INSTALLATION

Inspect all tubing regularly and replace if any sign of deterioration occurs. Always wear safety glasses and protective clothing when working with chemicals. See chart below for proper tubing installation procedure for your unit.

*909-014	Procedure A (below)
909-023 through 909-049	Procedure A or B (below or page 6)
909-058 through 909-282	Procedure B or C (page 6 or 7)

*** WARNING: MODEL 909-014 GEARTRAIN CAN BE DAMAGED IF THE DRIVE SHAFT IS ROTATED BY HAND FOR TUBE INSERTION.**

PROCEDURE A

(If unit is new start with step number 6.)

1. Disconnect power to the pump.
2. Disconnect the suction and discharge tubing from the pump tubing.
3. Remove four screws and pump cover from pump head.
4. Pull out old pump tubing and discard.
5. Clean roller race, removing any particles that could damage tubing.
6. Connect power and run at slowest speed until roller bracket assembly is in position as shown in figure 1.
7. Push new tubing into inlet port, anchoring tubing in grippers. If using a 9" piece of tube, 1 1/2" should be extended outside of inlet port. (figure 2)
8. Continue to run at slowest speed carefully feeding tube into race as the rollers turn. (Figure 3) (**KEEP FINGERS AWAY FROM ROLLERS.**)
9. Insert tubing into outlet port (figure 4) and replace cover.

